

Data Sheet



Article number: 390215003054010

Description: Worm gear
VF 150-FC2-30-100B5, without lubrication

Measures

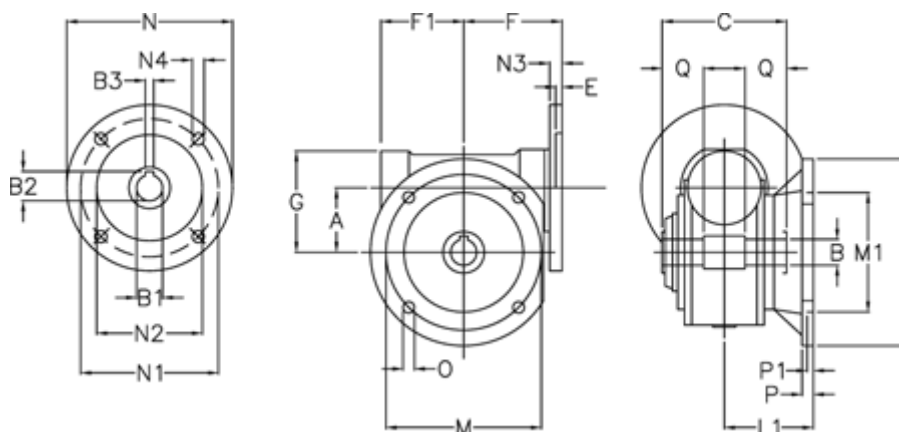

| | | |
|------------|------------|----------|
| A = 150 | F1 = 179 | N2 = 180 |
| B = 50 H7 | G = 218 | N3 = 11 |
| B1 E7 = 28 | L = 350 | N4 = 13 |
| B2 = 31.3 | L1 = 145.5 | O = 18 |
| B3 H9 = 8 | M = 290 | P = 22 |
| C = 175 | M1 = 200 | P1 = 13 |
| E = 2 | N = 250 | Q = 55 |
| F = 190 | N1 = 215 | |